

## Thermally-Enhanced High Power RF LDMOS FETs 130 W, 2420 – 2480 MHz

### Description

The PTFA241301E and PTFA241301F are thermally-enhanced 130-watt, internally matched *GOLDMOS*<sup>®</sup> FETs intended for ultra-linear applications. They are characterized for CDMA, CDMA2000, Super3G (3GPP TSG RAN), and WiMAX operation from 2420 to 2480 MHz. Full gold metallization ensures excellent device lifetime and reliability.

PTFA241301E  
 Package H-30260-2

PTFA241301F  
 Package H-31260-2

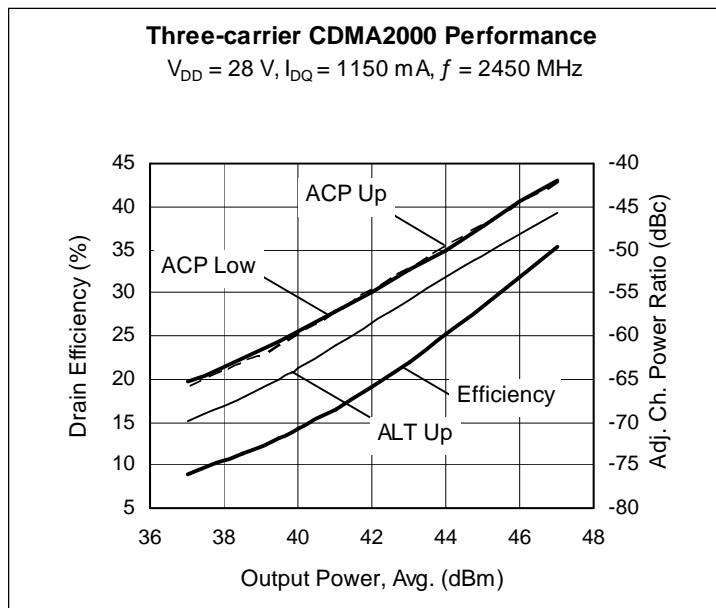
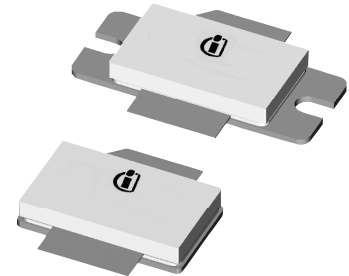

### Features

- Thermally-enhanced packaging, Pb-free and RoHS-compliant
- Broadband internal matching
- Typical CDMA2000 performance at 2450 MHz
  - Average output power = 25 W
  - Linear Gain = 14 dB
  - Efficiency = 25%
- Typical CW performance, 2420 MHz, 28 V
  - Output power at P-1dB = 140 W
  - Efficiency = 50%
- Integrated ESD protection: Human Body Model, Class 2 (minimum)
- Excellent thermal stability, low HCI drift
- Capable of handling 10:1 VSWR @ 28 V, 130 W (CW) output power

### RF Characteristics

**Three-carrier CDMA2000 Measurements** (not subject to production test—verified by design/characterization in Infineon test fixture)

$V_{DD} = 28\text{ V}$ ,  $I_{DQ} = 1150\text{ mA}$ ,  $P_{OUT} = 25\text{ W}$  average,  $f = 2450\text{ MHz}$

Characteristic	Symbol	Min	Typ	Max	Unit
Gain	$G_{ps}$	—	14	—	dB
Drain Efficiency	$\eta_D$	—	25	—	%
Adjacent Channel Power Ratio	ACPR	—	-50	—	dBc

All published data at  $T_{CASE} = 25^\circ\text{C}$  unless otherwise indicated

**ESD:** Electrostatic discharge sensitive device—observe handling precautions!

## RF Characteristics (cont.)

### Two-tone Measurements (tested in Infineon test fixture)

$V_{DD} = 28\text{ V}$ ,  $I_{DQ} = 1150\text{ mA}$ ,  $P_{OUT} = 130\text{ W PEP}$ ,  $f = 2420\text{ MHz}$ , tone spacing = 1 MHz

Characteristic	Symbol	Min	Typ	Max	Unit
Gain	$G_{ps}$	13.0	14	—	dB
Drain Efficiency	$\eta_D$	36	38	—	%
Intermodulation Distortion	IMD	—	-30	-28	dBc

## DC Characteristics

Characteristic	Conditions	Symbol	Min	Typ	Max	Unit
Drain-Source Breakdown Voltage	$V_{GS} = 0\text{ V}$ , $I_{DS} = 10\text{ mA}$	$V_{(BR)DSS}$	65	—	—	V
Drain Leakage Current	$V_{DS} = 28\text{ V}$ , $V_{GS} = 0\text{ V}$	$I_{DSS}$	—	—	1.0	$\mu\text{A}$
	$V_{DS} = 63\text{ V}$ , $V_{GS} = 0\text{ V}$	$I_{DSS}$	—	—	10.0	$\mu\text{A}$
On-State Resistance	$V_{GS} = 10\text{ V}$ , $V_{DS} = 0.1\text{ V}$	$R_{DS(on)}$	—	0.07	—	$\Omega$
Operating Gate Voltage	$V_{DS} = 28\text{ V}$ , $I_{DQ} = 1150\text{ mA}$	$V_{GS}$	2	2.4	3	V
Gate Leakage Current	$V_{GS} = 10\text{ V}$ , $V_{DS} = 0\text{ V}$	$I_{GSS}$	—	—	1.0	$\mu\text{A}$

## Maximum Ratings

Parameter	Symbol	Value	Unit
Drain-Source Voltage	$V_{DSS}$	65	V
Gate-Source Voltage	$V_{GS}$	-0.5 to +12	V
Junction Temperature	$T_J$	200	$^{\circ}\text{C}$
Total Device Dissipation	$P_D$	438	W
		Above 25 $^{\circ}\text{C}$ derate by	2.5
Storage Temperature Range	$T_{STG}$	-40 to +150	$^{\circ}\text{C}$
Thermal Resistance ( $T_{CASE} = 70^{\circ}\text{C}$ , 130 W CW)	$R_{\theta JC}$	0.40	$^{\circ}\text{C}/\text{W}$

## Ordering Information

Type	Package Outline	Package Description	Marking
PTFA241301E	H-30260-2	Thermally-enhanced slotted flange, single-ended	PTFA241301E
PTFA241301F	H-31260-2	Thermally-enhanced earless flange, single-ended	PTFA241301F

**Typical Performance** (data taken in a production test fixture)

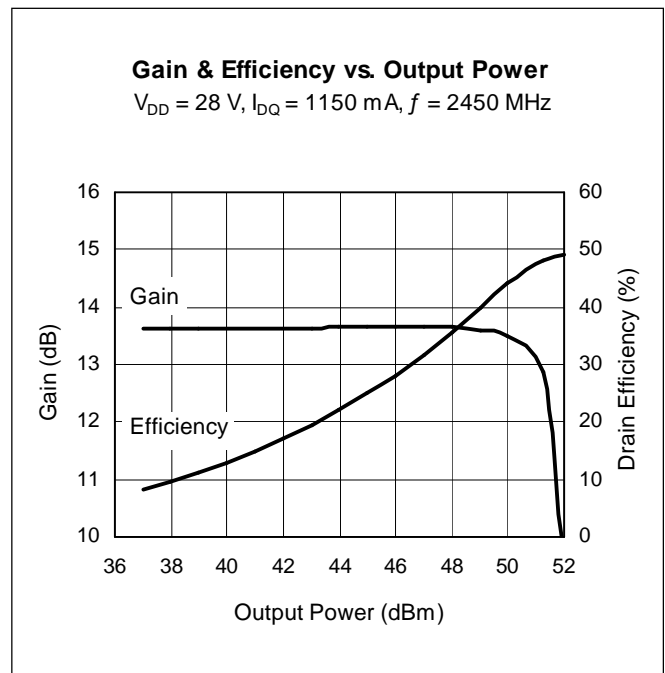
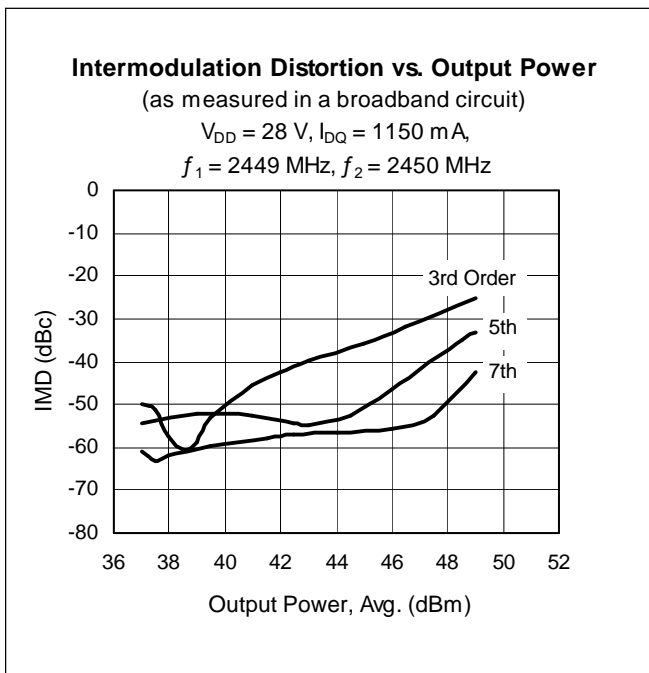
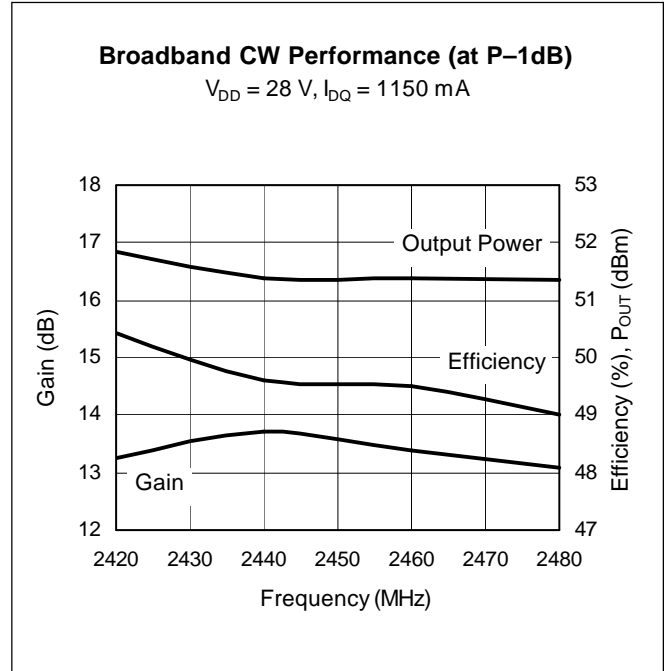
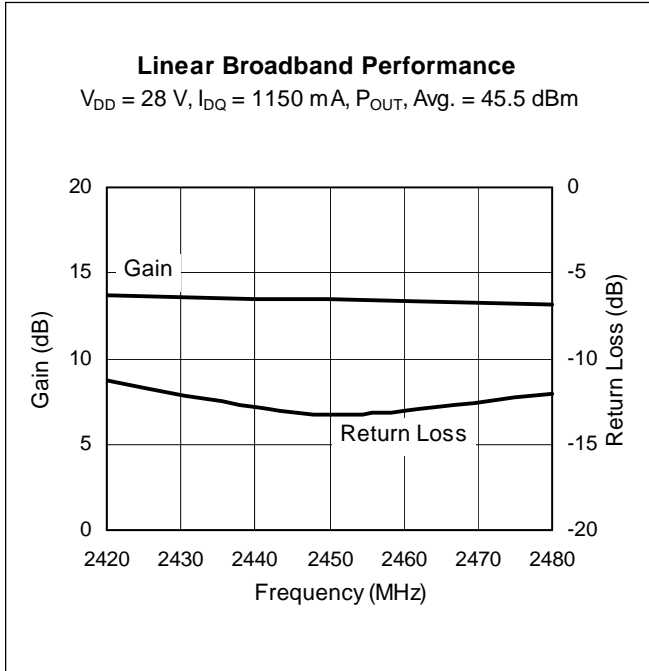

Typical Performance (cont.)

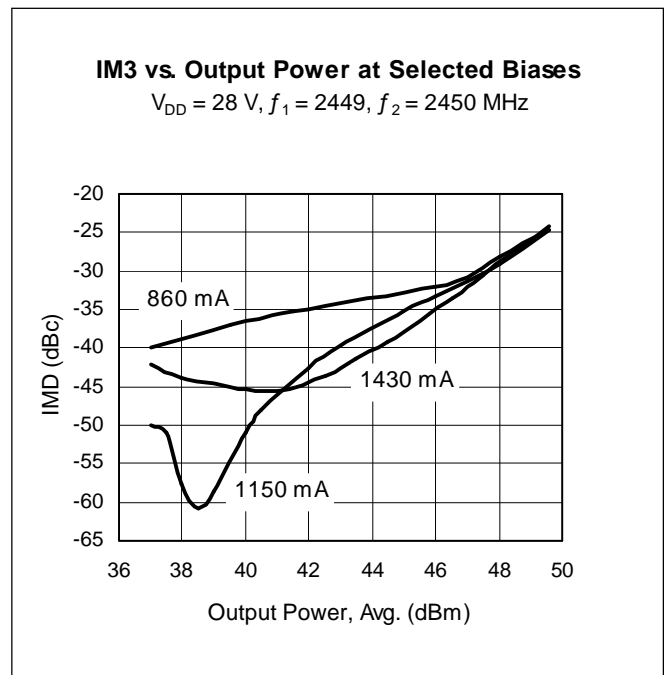
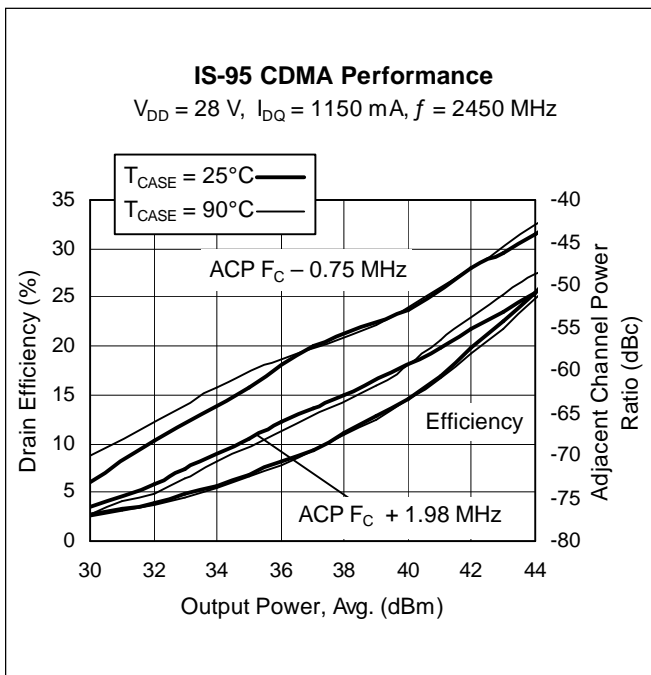
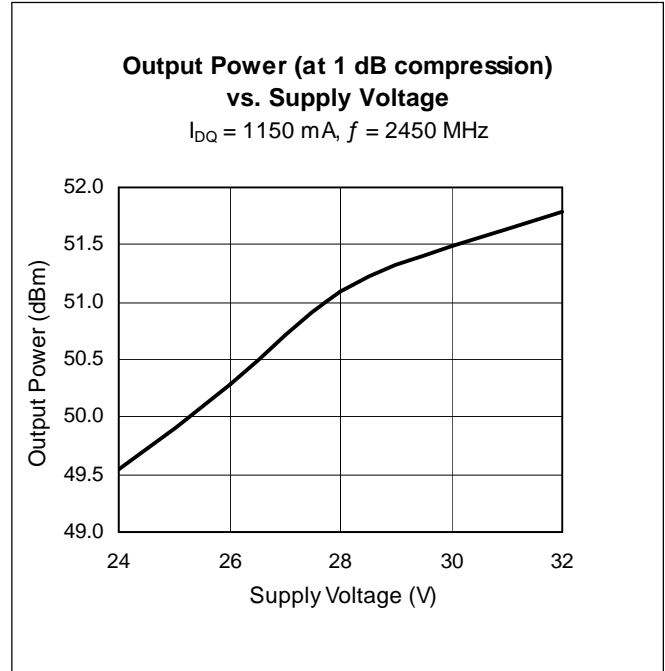
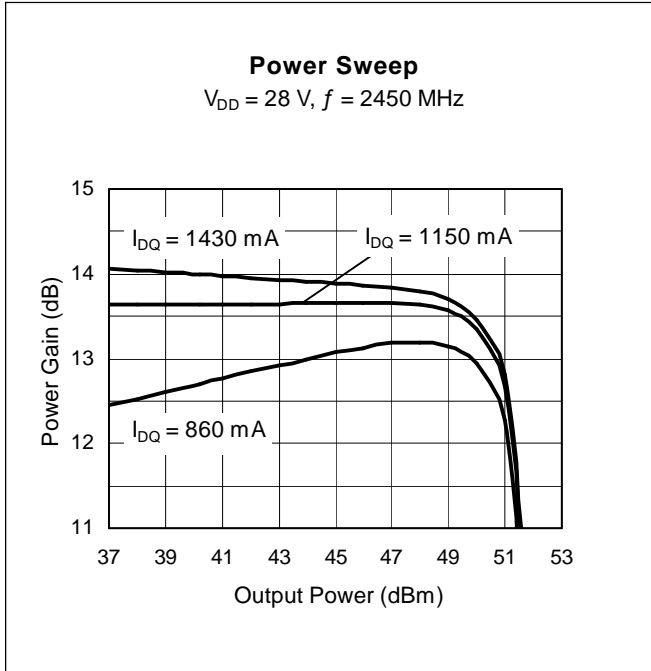

**Typical Performance (cont.)**

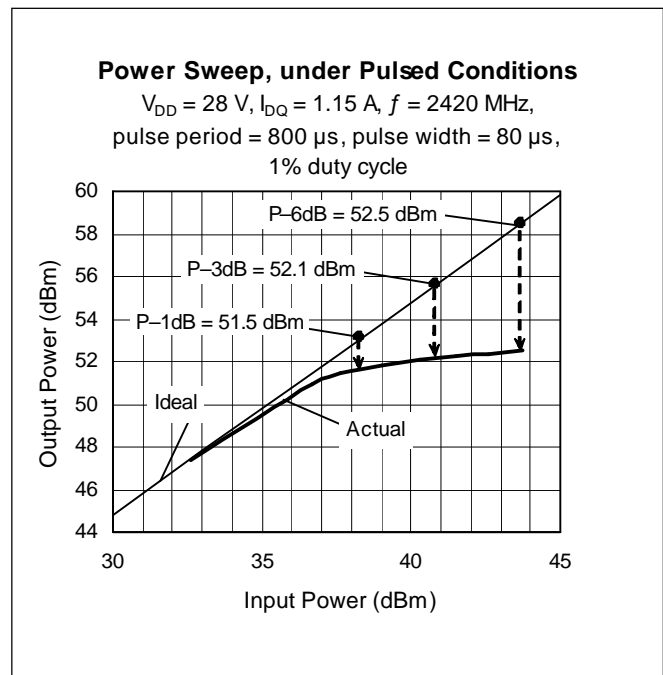
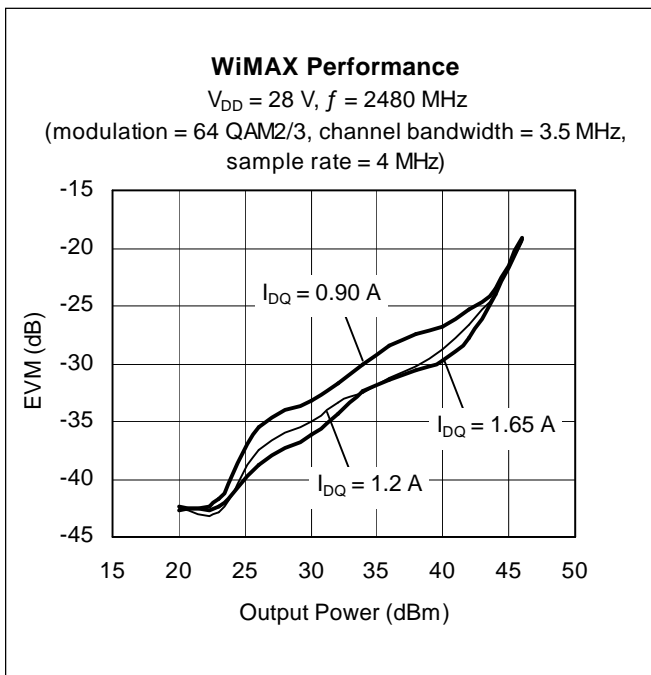
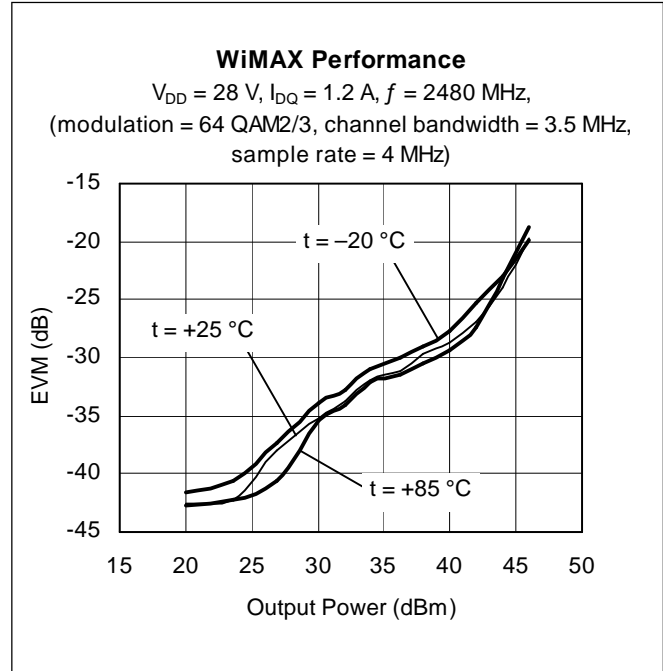
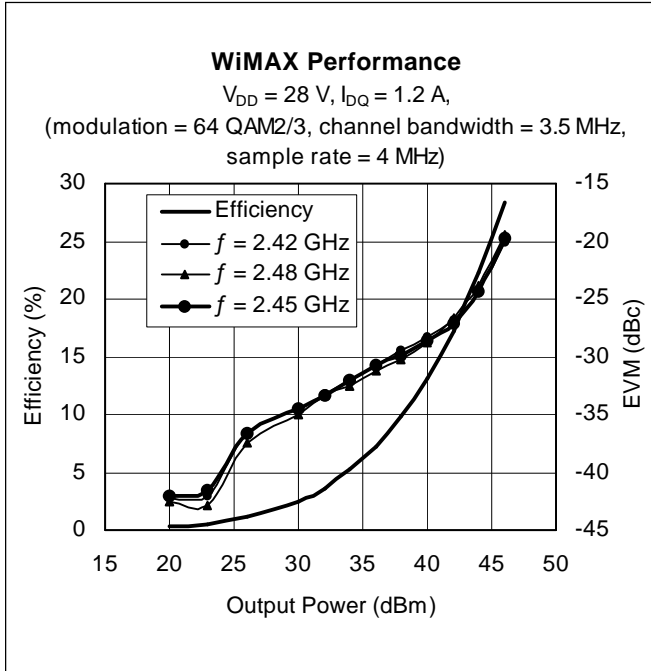

Typical Performance (cont.)

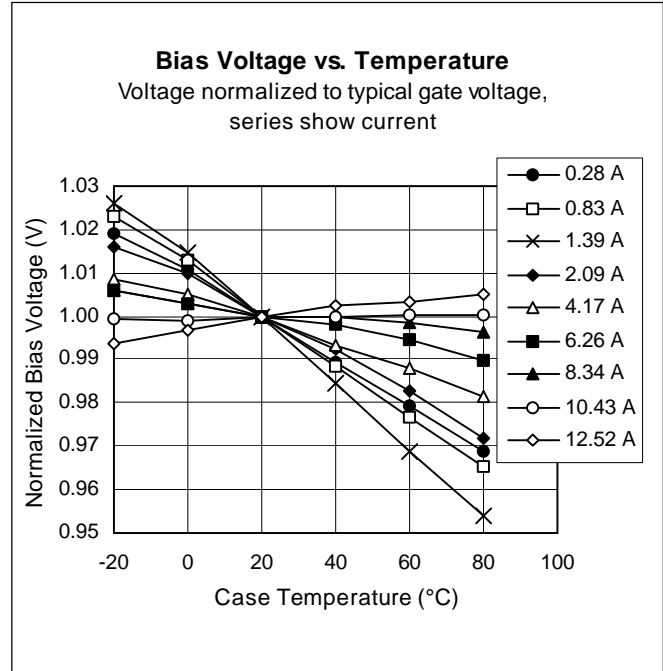
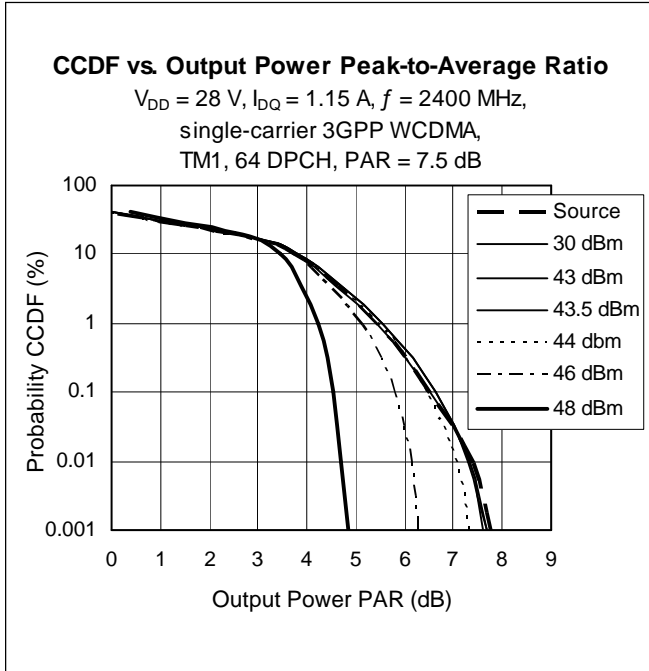

Broadband Circuit Impedance

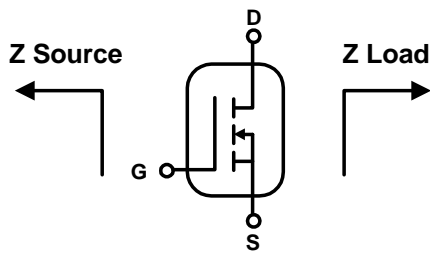

Frequency MHz	Z Source W		Z Load W	
	R	jX	R	jX
2420	13.20	4.69	1.35	4.73
2430	13.30	4.75	1.28	4.80
2450	13.85	4.94	1.14	4.99
2470	14.59	5.00	1.06	5.27
2480	15.01	4.91	1.01	5.43

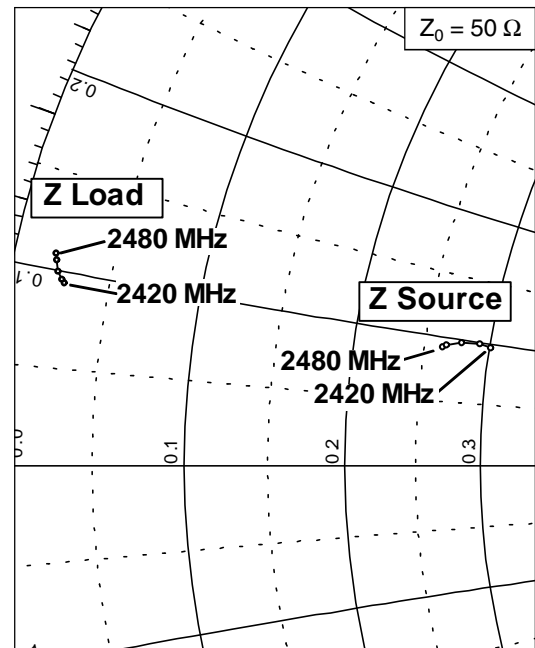

See next page for circuit information

## Reference Circuit

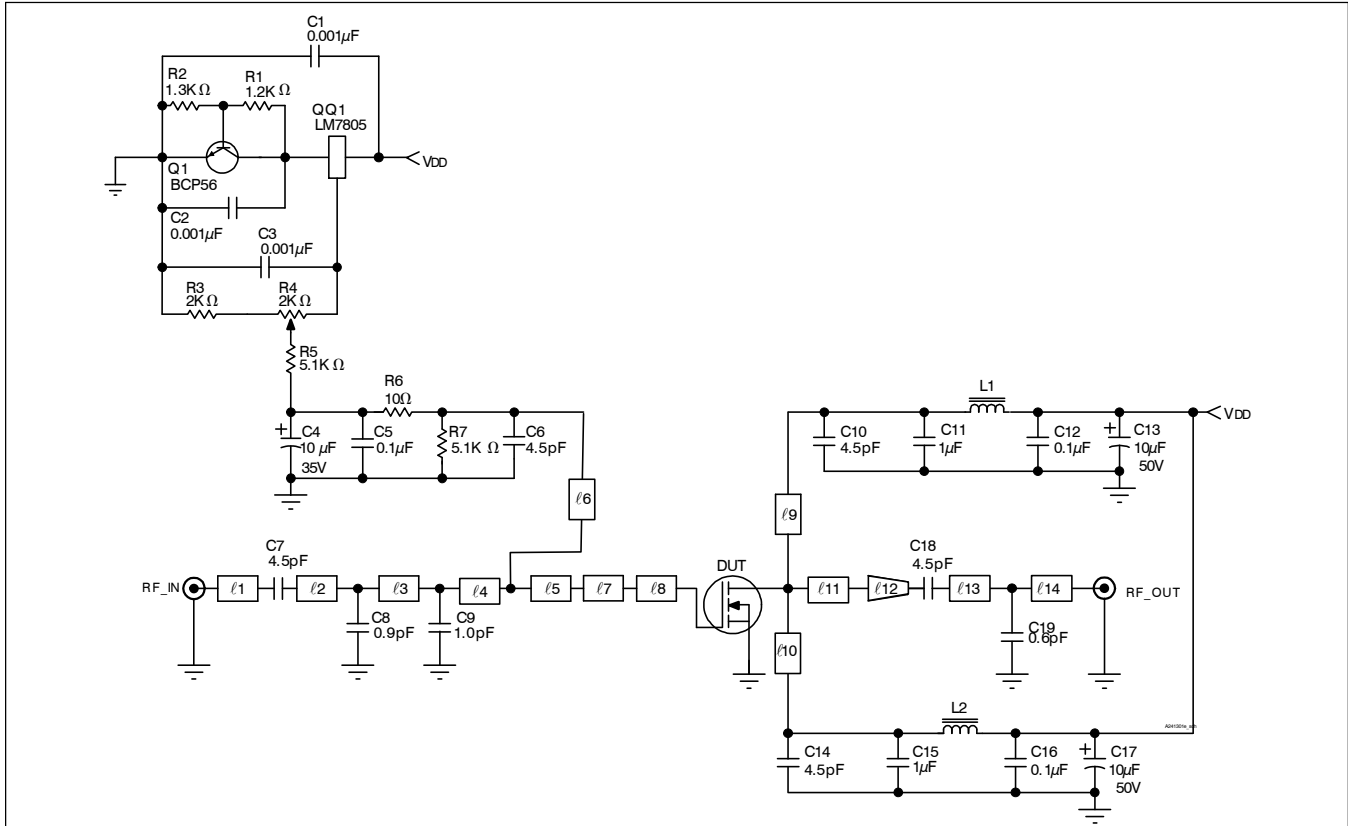

Reference circuit schematic for  $f = 2420$  MHz

### Circuit Assembly Information

DUT	PTFA241301E or PTFA241301F	LDMOS Transistor	
PCB	0.76 mm [.030"] thick, $\epsilon_r = 4.5$	Rogers TMM4	2 oz. copper

Microstrip	Electrical Characteristics at 2420 MHz <sup>1</sup>	Dimensions: L x W (mm)	Dimensions: L x W (in.)
l1	0.112 $\lambda$ , 50.0 $\Omega$	7.52 x 1.37	0.296 x 0.054
l2	0.039 $\lambda$ , 34.0 $\Omega$	2.54 x 2.54	0.100 x 0.100
l3	0.045 $\lambda$ , 34.0 $\Omega$	2.92 x 2.54	0.115 x 0.100
l4	0.044 $\lambda$ , 34.0 $\Omega$	2.87 x 2.54	0.113 x 0.100
l5	0.017 $\lambda$ , 34.0 $\Omega$	1.09 x 2.54	0.043 x 0.100
l6	0.307 $\lambda$ , 60.0 $\Omega$	21.01 x 0.97	0.827 x 0.038
l7	0.019 $\lambda$ , 14.7 $\Omega$	1.17 x 7.62	0.046 x 0.300
l8	0.083 $\lambda$ , 8.0 $\Omega$	5.03 x 15.24	0.198 x 0.600
l9, l10	0.237 $\lambda$ , 50.0 $\Omega$	16.00 x 1.27	0.630 x 0.050
l11	0.057 $\lambda$ , 4.3 $\Omega$	3.43 x 29.85	0.135 x 1.175
l12 (taper)	0.098 $\lambda$ , 4.3 $\Omega$ / 50.0 $\Omega$	5.99 x 29.85 / 1.37	0.236 x 1.175 / 0.054
l13	0.034 $\lambda$ , 50.0 $\Omega$	2.29 x 1.37	0.090 x 0.054
l14	0.164 $\lambda$ , 50.0 $\Omega$	11.13 x 1.37	0.438 x 0.054

<sup>1</sup>Electrical characteristics are rounded.

Reference Circuit (cont.)

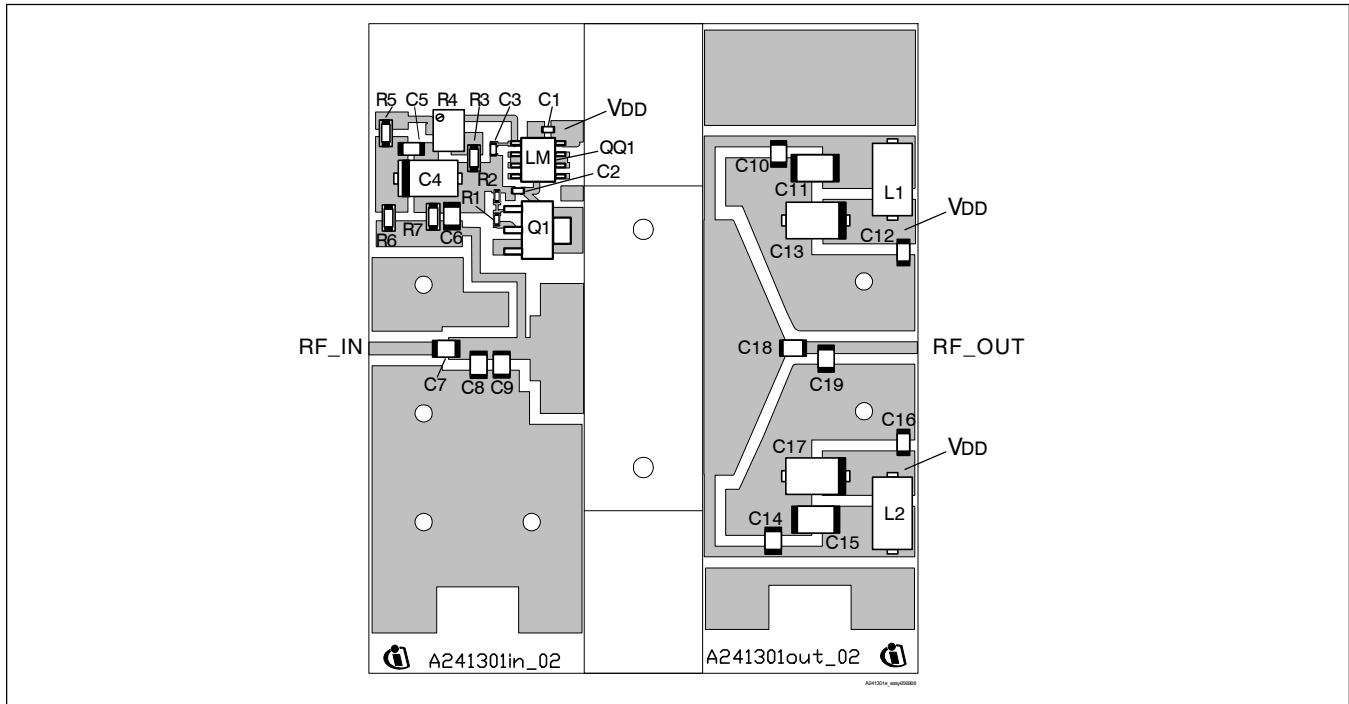

Reference circuit assembly diagram\* (not to scale)

Component	Description	Suggested Manufacturer	P/N or Comment
C1, C2, C3	Capacitor, 0.001 $\mu$ F	Digi-Key	PCC1772CT-ND
C4	Tantalum capacitor, 10 $\mu$ F, 35 V	Digi-Key	366-1655-2-ND
C5, C12, C16	Capacitor, 0.1 $\mu$ F	Digi-Key	PCC104BCT-ND
C6, C7, C10, C14, C18	Ceramic capacitor 4.5 pF	ATC	100B 4R5
C8	Ceramic capacitor 0.9 pF	ATC	100B 0R9
C9	Ceramic capacitor 1 pF	ATC	100B 1R0
C11, C15	Ceramic capacitor 1 $\mu$ F	Digi-Key	19528-ND
C13, C17	Capacitor, 10 $\mu$ F, 50 V	Garrett Electronics	TPS106K050R0400
C19	Ceramic capacitor 0.6 pF	ATC	100B 0R6
L1, L2	Ferrite, 6 mm	Ferroxcube	53/3/4.6-452
Q1	Transistor	Infineon Technologies	BCP56
QQ1	Voltage regulator,	National Semiconductor	LM7805
R1	Chip resistor, 1.2 k-ohms	Digi-Key	P1.2KGCT-ND
R2	Chip resistor, 1.3 k-ohms	Digi-Key	P1.3KGCT-ND
R3	Chip resistor, 2 k-ohms	Digi-Key	P22KECT-ND
R4	Potentiometer, 2 k-ohms	Digi-Key	3224W-202ETR-ND
R5, R7	Chip resistor, 5.1 k-ohms	Digi-Key	P5.1KECT-ND
R6	Chip resistor, 10 ohms	Digi-Key	P10ECT-ND

\*Gerber Files for this circuit available on request





Package Outline Specifications (cont.)

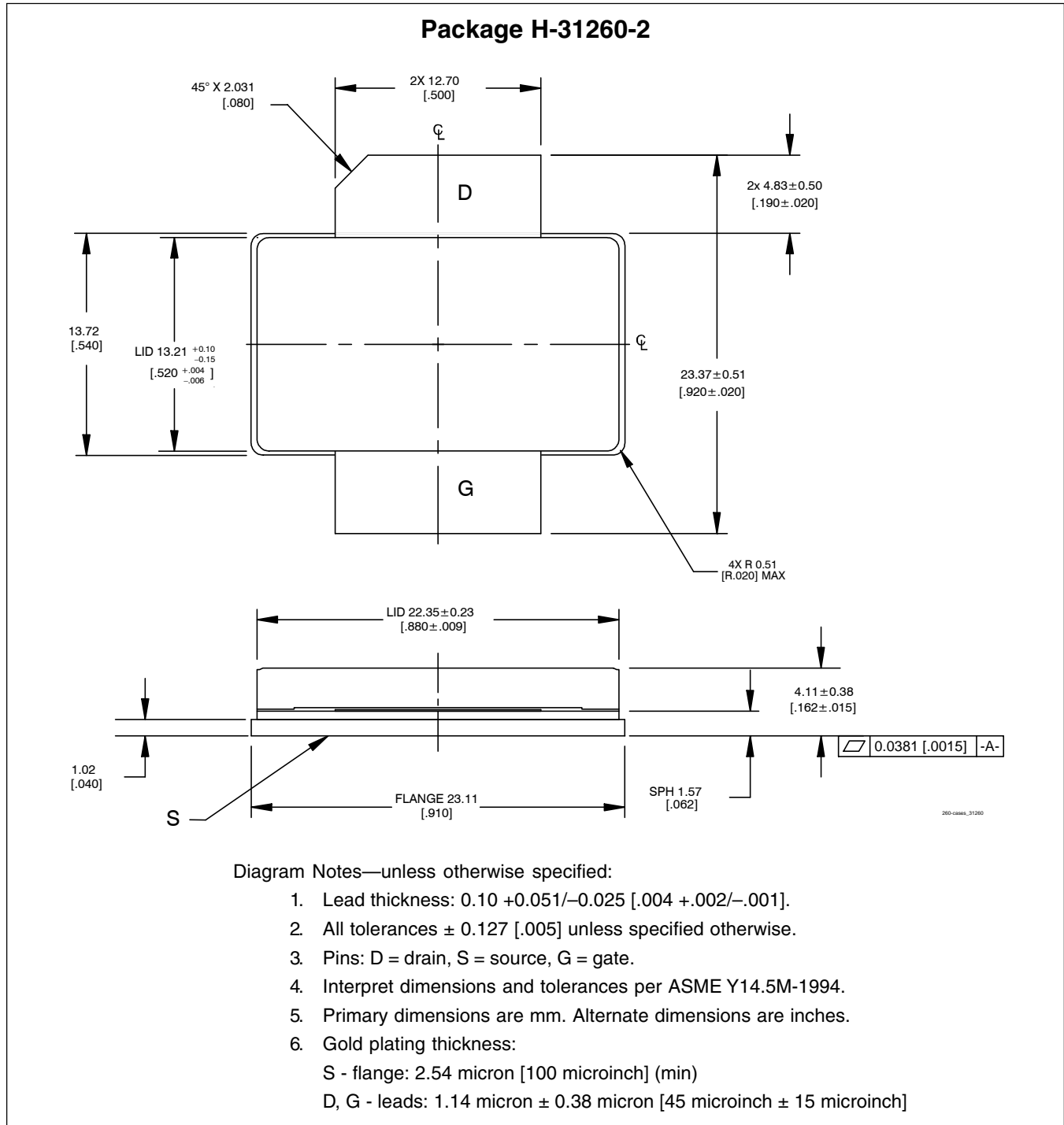

Find the latest and most complete information about products and packaging at the Infineon Internet page <http://www.infineon.com/products>

---

**PTFA241301EF****Revision History:**           **2007-05-11**

Data Sheet

Previous Version:           2006-06-29, Data Sheet

Page	Subjects (major changes since last revision)
5, 6	Add two graphs.
9	Update package outline diagram for Package H-30260-2.

**Notes:**

### We Listen to Your Comments

Any information within this document that you feel is wrong, unclear or missing at all?  
Your feedback will help us to continuously improve the quality of this document.  
Please send your proposal (including a reference to this document) to:

**highpowerRF@infineon.com**

To request other information, contact us at:  
+1 877 465 3667 (1-877-GO-LDMOS) USA  
or +1 408 776 0600 International

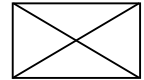

*GOLDMOS*<sup>®</sup> is a registered trademark of Infineon Technologies AG.

**Edition 2007-05-11**

**Published by  
Infineon Technologies AG  
81726 München, Germany**

**© Infineon Technologies AG 2005.  
All Rights Reserved.**

### Legal Disclaimer

The information given in this document shall in no event be regarded as a guarantee of conditions or characteristics (“Beschaffenheitsgarantie”). With respect to any examples or hints given herein, any typical values stated herein and/or any information regarding the application of the device, Infineon Technologies hereby disclaims any and all warranties and liabilities of any kind, including without limitation warranties of non-infringement of intellectual property rights of any third party.

### Information

For further information on technology, delivery terms and conditions and prices please contact your nearest Infineon Technologies Office ([www.infineon.com/rfpower](http://www.infineon.com/rfpower)).

### Warnings

Due to technical requirements components may contain dangerous substances. For information on the types in question please contact your nearest Infineon Technologies Office.

Infineon Technologies Components may only be used in life-support devices or systems with the express written approval of Infineon Technologies, if a failure of such components can reasonably be expected to cause the failure of that life-support device or system, or to affect the safety or effectiveness of that device or system. Life support devices or systems are intended to be implanted in the human body, or to support and/or maintain and sustain and/or protect human life. If they fail, it is reasonable to assume that the health of the user or other persons may be endangered.